

YardBright®

LOW VOLTAGE GARDEN

LIGHT TRANSFORMER

600WATTS

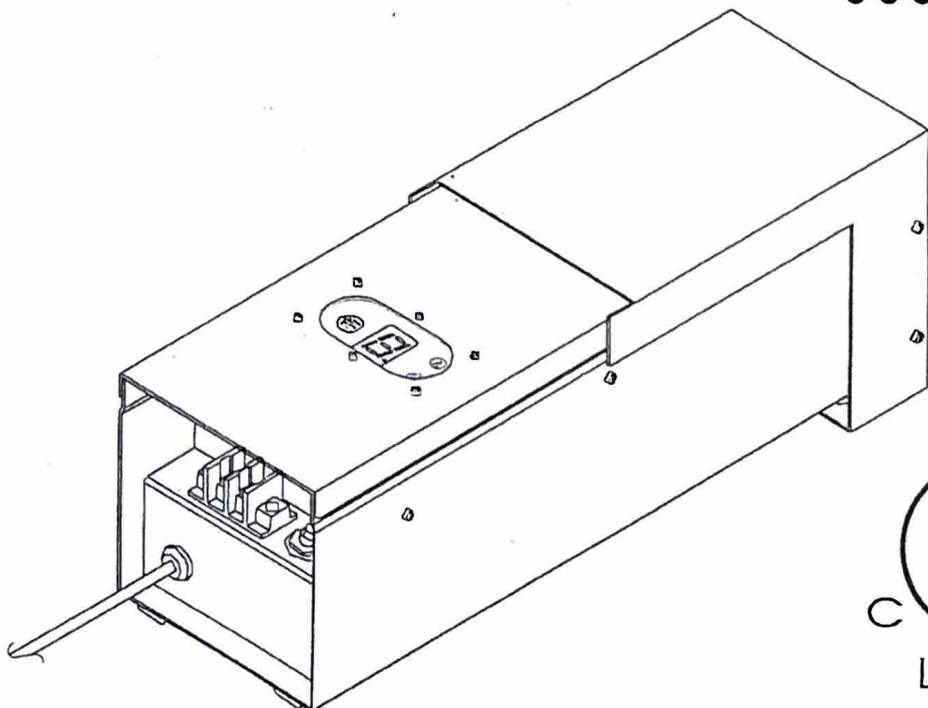

LISTED

E181950

5G45

MODEL NO: GBPTST600-12(PYST-60012)

LANDSCAPE LIGHTING TRANSFORMER INSTRUCTIONS

MODEL NO: GBTPTST600-12(PTST-60012)

A. Profile

This unit is a functional and intelligent Low Voltage Lighting Transformer. It is engineered to meet the highest standards of Quality and Workmanship that will last for many years to come. This unit was designed for simple use that anyone can operate through the use of advanced Photo Cell technology.

A1. Functional:

- A1-1. Light Control: Lights will turn on automatically at dusk
- A1-2. After sensing that it is night time, the unit will turn on automatically after 30 seconds to avoid any false darkening conditions that may turn the lights on.
- A1-3. Timer Control: There are several options for the amount of time you want your lights on. You can choose for the lights to operate from Dusk until Dawn or choose the lights to stay on for a set number of hours from 1-9. In any case, once the unit detects sunlight, it will turn off.
- A1-4. The unit will continue to control the garden lights on this same setting every day until the setting is changed on the control panel.
- A1-5. Circuit Protection: When this unit senses there is a short circuit in the 12v output due to wires being crossed or a faulty connection, the unit will trip the circuit breaker to protect it from damage. Disconnect power, and determine where the short is. Once it is detected and repaired, reset the circuit breaker (See Drawing 3) and test to make sure bulbs function properly.

B. Installation

B1. Installation Instructions:

- B1-1. Two holes are on the back of the Unit for mounting. Check the distance between the two holes before permanently mounting to ensure correct placement of screws. (See Drawing 1)
- B1-2. Drive screws onto a solid surface to the wall. These units are heavy and require that they are mounted to a solid structure. This unit should be placed in an area that has ample daylight. If not, the lights may not come on at the proper times. Make sure the unit is at least 3 feet from the ground. (See Drawing 2)
- B1-3. Output connection: Connect the two wires as shown. (See Drawing 3)

B2. Attention:

- B2-1. Do not install this unit where it is blocked from the sunlight. The unit may not function properly.

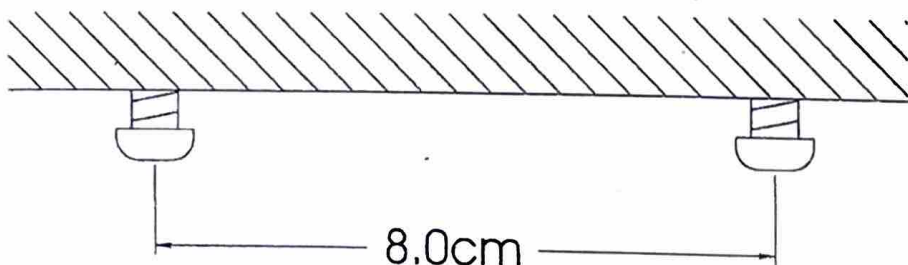

DRAWING 1

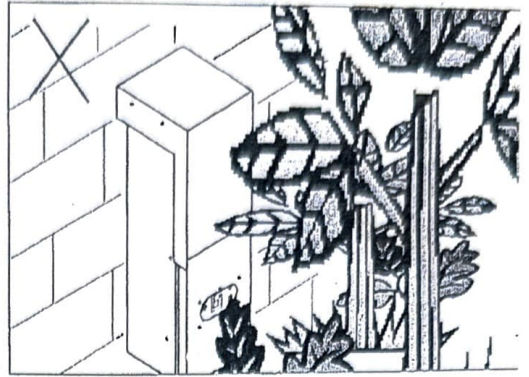
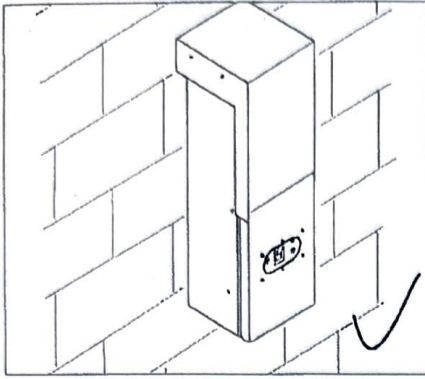

DRAWING 2

- B2-2. This unit should only be operated between -22°F and 104°F . The unit may not function properly if the temperature extremes are exceeded for long periods of time.
- B2-3. This unit must be mounted a minimum of 3 feet from the ground. This unit is for outdoor installation. The unit must be mounted within 100 cable feet of all fixtures connected to it. This unit is intended ONLY for use on a 12v Landscape Lighting System.
- B2-4. Use 10AWG outdoor landscape lighting cable (or suitable approved cable) for the connection of at least 600w.

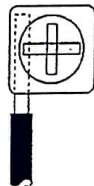
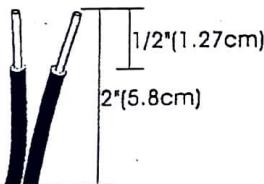

Position 1 wire under each terminal pressure plate and *tighten screw securely*. Make sure wire insulation clears pressure plate.

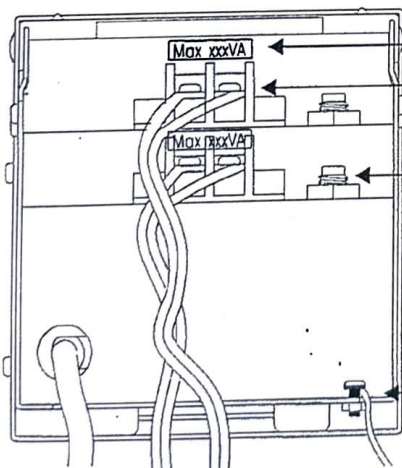

Total bulb's wattage doesn't exceed max wattage.

Tighten screws securely

RESET SWITCH-Press to reset transformer if lights go out

Connected Ground

DRAWING 3

For use with low voltage outdoor landscape lighting system only, not for use with submersible or pool/spa equipment.

* Transformers with ground shield for use with outdoor low voltage landscape lighting.

C. Usage

C1. When the unit is mounted, Open the front cover and plug the power cord into an approved household receptacle. The following will be displayed:

" . " : Unit plugged In, Lights are off, and will not turn on.

Use the ▼ OR ▲ to cycle through the different lighting time options.

"0" : Power On, Light will remain on indefinitely.

"A" : Auto. Lights will turn on at Dusk and turn off at Dawn.

"1-9" : Auto Timed. Lights will turn on at dusk, and turn off after a programmed number of hours. For example, if you select 5, the lights will turn on at Dusk, and turn off after 5 hours.

"▲" Goes in right order: ,0,A,1,2,3,4,5,6,7,8,9

"▼" Goes in left order: ,9,8,7,6,5,4,3,2,1,A,0

C2. Important:

If the operating time is changed during a dusk light cycle, it will not turn off at the new programmed time. The new programmed time will be in effect during the next cycle the following day.

C3. Control Panel Display (See Drawing 4)

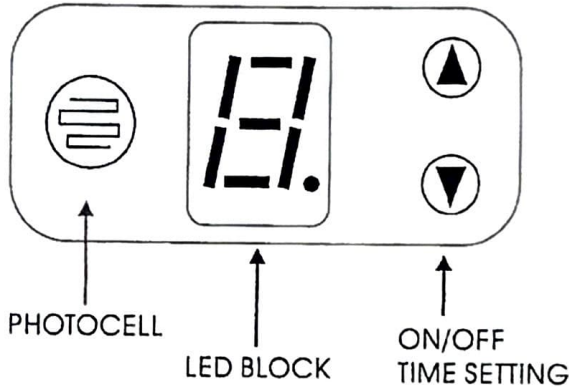

DRAWING 4

D. Troubleshooting

If the lights do not come on, please check the following:

- The Control Panel digits do not come on
 - Check to make sure Power is plugged in
 - Check that there is power to the outlet
 - Check home circuit breakers or fuses.
- The Landscape Lights do not come on
 - Press ▼ ▲ to adjust display to 0 (Constant On)
 - Check Circuit Breaker on the Unit. Press to Reset
 - Check the connection between Output Cable and the unit. Make sure all wires are connected.
 - Check to make sure Connections are not corroded. If corroded, clean and replace wires.
 - Screw all connection tightly.
 - When reset the power or digital panel display, please wait for 30secs
- Contact your YardBright Distributor or search our website for additional information.

! Please read and obey all Warning on the unit

! Please follow all directions included on this instruction sheet.

! Laws or Ordinances may exist in your state or area. Please check with all local laws before installation.